

Overview

- *The Discrete Fourier Transform*
 - *Concept*
 - *Review on the Fourier representation of signals*
 - *case 1: aperiodic continuous-time signal*
 - *case 2: periodic continuous-time signal*
 - *case 3: aperiodic discrete-time signal*
 - *case 4: periodic discrete-time signal*
 - *The discrete Fourier series*
 - *The sampling of the Fourier transform*
 - *The discrete Fourier transform (DFT)*
 - *definition*
 - *Properties of the DFT*
 - *linearity*
 - *circular shift*
 - *duality*
 - *symmetry*
 - *circular convolution*

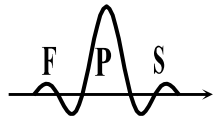

The Discrete Fourier Transform (DFT)

- Concept
 - the different faces of the Fourier synthesis/analysis...

$$\tilde{x}[n] = \frac{1}{N} \sum_{k=0}^{N-1} \tilde{X}[k] e^{jk \frac{2\pi}{N} n}$$

The discrete Fourier transform
(N-periodic in n and k)

$$x[n] = \frac{1}{2\pi} \int_{-\pi}^{\pi} \tilde{X}(e^{j\omega}) e^{j\omega n} d\omega$$

The discrete-time Fourier transform
(2π -periodic in ω)

$$x(t) = \frac{1}{2\pi} \int_{-\infty}^{+\infty} X(\Omega) e^{j\Omega t} d\Omega$$

The continuous-time Fourier transform
(in t and Ω)

$$\tilde{x}(t) = \frac{1}{2} a_0 + \sum_{k=1}^{+\infty} \left[a_k \cos\left(k \frac{2\pi}{T} t\right) + b_k \sin\left(k \frac{2\pi}{T} t\right) \right]$$

The Fourier series
(T-periodic in t)

$$\tilde{x}(t) = \frac{1}{T} \sum_{k=-\infty}^{+\infty} c_k e^{jk \frac{2\pi}{T} t}$$

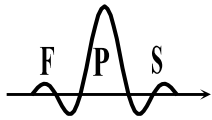

The Discrete Fourier Transform (DFT)

- Concept
 - It is an alternative to the Fourier transform or to the Z transform to represent finite sequences describing discrete-time signals and linear time-invariant systems,
 - The DFT is a discrete sequence, while the Fourier transform or the Z transform are functions of continuous variables,
 - the DFT corresponds to a sampling of the Fourier transform using equidistant samples in frequency,
 - the DFT is very important in many signal processing applications because efficient algorithms exist (e.g., the FFT, as we shall see) allowing the fast computation of the DFT, which permits the utilization of the DFT, for example, in real-time spectral analysis applications.

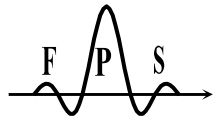

The Fourier representation of signals

→ Case 1

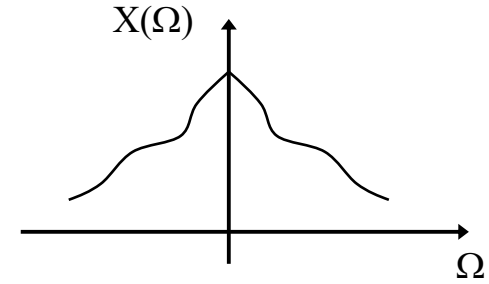
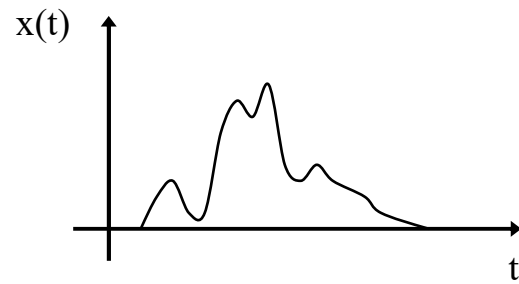

→ Case 2

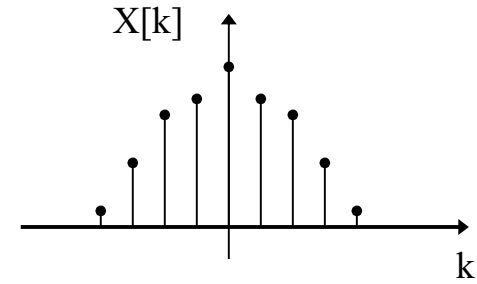
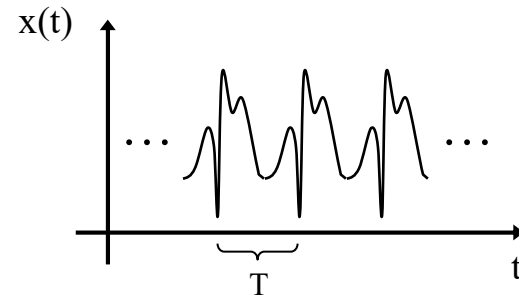

→ Case 3

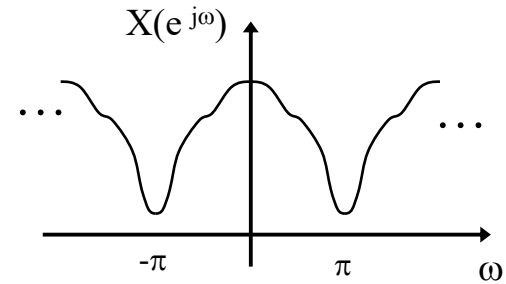
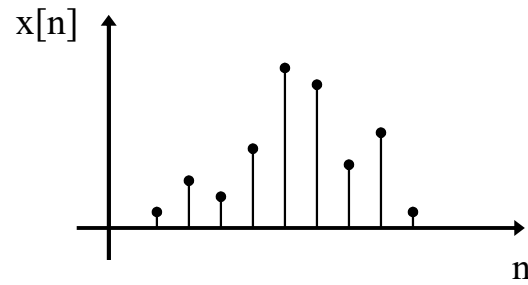

→ Case 4

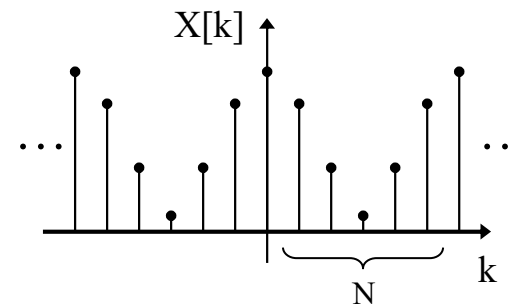
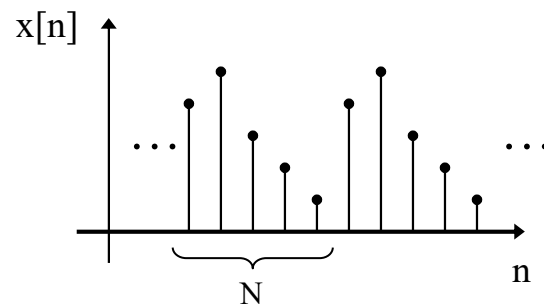

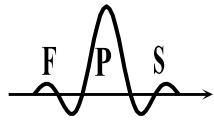

The Fourier representation of signals

- Review on the Fourier representation of signals
 - we should be familiar already with the Fourier representation of aperiodic continuous-time signals, periodic continuous-time signals, and aperiodic discrete-time signals. The Fourier representation of periodic discrete-time signals is another important case of Fourier representation that consists in the discrete Fourier transform.

→ Case 1: aperiodic continuous-time signal

- $x(t)$ is aperiodic, $X(\Omega)$ is aperiodic.

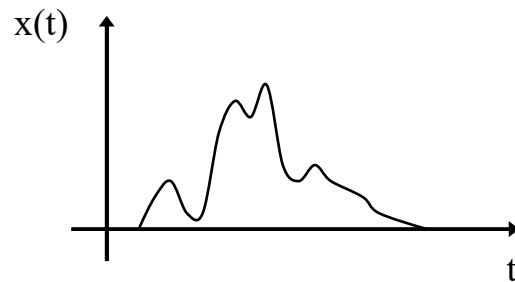

$$x(t) = \frac{1}{2\pi} \int_{-\infty}^{+\infty} X(\Omega) e^{j\Omega t} d\Omega$$

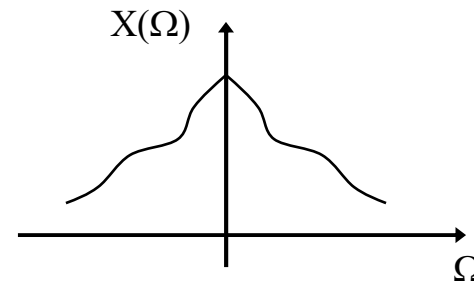

$$X(\Omega) = \int_{-\infty}^{+\infty} x(t) e^{-j\Omega t} dt$$

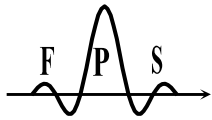

The Fourier representation of signals

→ Case 2: periodic continuous-time signal

- $\tilde{x}(t)$ is continuous and periodic (with period T),
- its spectrum, $X[k]$, is described by an aperiodic Fourier series, with an infinite number of coefficients that are associated with complex exponentials whose frequencies are multiple integers (*i.e.*, harmonic) of the fundamental frequency $\Omega=2\pi/T$.

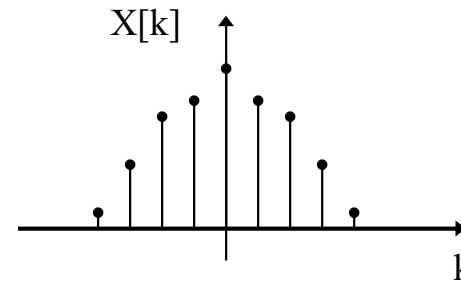
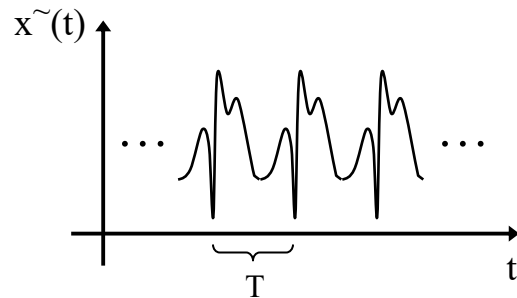

$$\tilde{x}(t) = \frac{1}{T} \sum_{k=-\infty}^{+\infty} X[k] e^{jk \frac{2\pi}{T} t}$$

$$X[k] = \int_T \tilde{x}(t) e^{-jk \frac{2\pi}{T} t} dt$$

$$\tilde{x}(t) = \tilde{x}(t + \ell T) \quad , \quad \forall \ell \text{ integer}$$

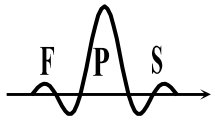

The Fourier representation of signals

→ Case 3: aperiodic discrete-time signal

- $x[n]$ is aperiodic discrete,
- $\tilde{X}(e^{j\omega})$ is continuous and periodic (with period 2π).

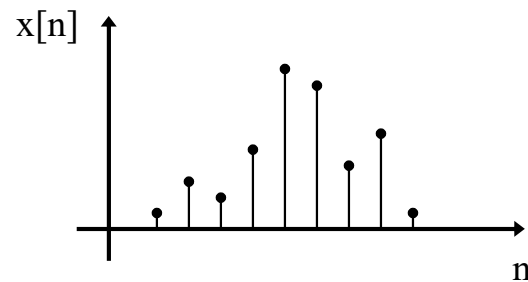

$$x[n] = \frac{1}{2\pi} \int_{2\pi} \tilde{X}(e^{j\omega}) e^{j\omega n} d\omega$$

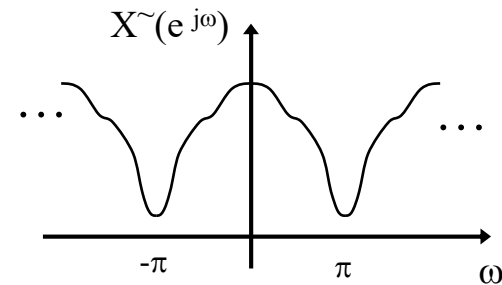

$$\tilde{X}(e^{j\omega}) = \sum_{n=-\infty}^{+\infty} x[n] e^{-j\omega n}$$

$$\tilde{X}(e^{j\omega}) = \tilde{X}(e^{j(\omega + \ell 2\pi)}) \quad , \quad \forall \ell \text{ integer}$$

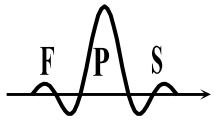

The Fourier representation of signals

→ Case 4: periodic discrete-time signal

- $\tilde{x}[n]$ is discrete and periodic (with period N),
- the spectrum of $\tilde{X}[k]$ is described by an N -periodic Fourier series (N is also the period of the periodic sequence $\tilde{x}[n]$) and their coefficients, $\tilde{X}[k]$, are associated with complex exponentials whose frequencies are harmonic of the fundamental frequency $\omega=2\pi/N$.

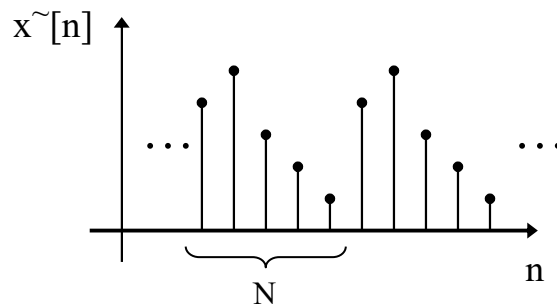

$$\tilde{x}[n] = \frac{1}{N} \sum_N \tilde{X}[k] e^{jk \frac{2\pi}{N} n}$$

$$\tilde{x}[n] = \tilde{x}[n + \ell N], \forall \ell \in \mathbb{Z}$$

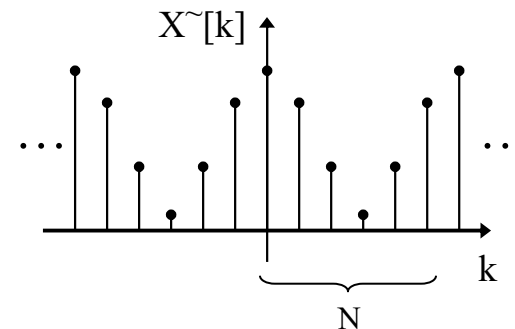

$$\tilde{X}[k] = \sum_N \tilde{x}[k] e^{-jk \frac{2\pi}{N} n}$$

$$\tilde{X}[k] = \tilde{X}[k + \ell N], \forall \ell \text{ integer}$$

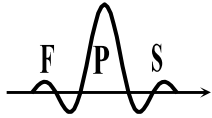

The Fourier representation of signals

- as a summary...
 - a simple conclusion can be extracted from the four different cases:
 - if the signal is periodic in one domain [time (t or n) or frequency (ω or k)], the signal consists in a set of “lines” in the other domain (frequency or time),
 - the fourth case (periodic Fourier series) is particularly interesting because:
 - it verifies in both domains the two conditions of periodicity and representation using “lines”,
 - only N points are necessary in the discrete n domain, or in the discrete frequency domain K , to describe completely a period of the signal.

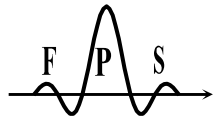

The discrete Fourier series

- definition
 - consists in the following Fourier pair that uses N points involving one period of the representation in n, or N points involving one period of the discrete representation in the frequency domain (the tilde symbolizes periodicity):

$$\tilde{x}[n] = \frac{1}{N} \sum_{k=0}^{N-1} \tilde{X}[k] W_N^{-kn} \quad \xleftrightarrow{F} \quad \tilde{X}[k] = \sum_{n=0}^{N-1} \tilde{x}[n] W_N^{kn}$$

where: $W_N = e^{-j\frac{2\pi}{N}}$

- Example: given a periodic signal with period N: $\tilde{x}[n] = \sum_{r=-\infty}^{+\infty} \delta[n - rN] = \begin{cases} 1, & n = rN, \quad r \text{ integer} \\ 0, & \text{other} \end{cases}$
and given that in a period only one non-zero impulse exists, we have:

$$\tilde{X}[k] = \sum_{n=0}^{N-1} \delta[n] W_N^{kn} = W_N^0 = 1 \quad \xleftrightarrow{F} \quad \tilde{x}[n] = \frac{1}{N} \sum_{k=0}^{N-1} W_N^{-kn} = \frac{1}{N} \sum_{k=0}^{N-1} e^{j\frac{2\pi}{N}kn}$$

but since: $\sum_{k=0}^{N-1} e^{j\frac{2\pi}{N}kn} = \begin{cases} N, & n \text{ multiple of } N \Leftrightarrow n = \ell N \\ 0, & \text{other} \end{cases}$

finally: $\tilde{x}[n] = \sum_{\ell=-\infty}^{+\infty} \delta[n - \ell N]$

NOTE: this result is important to characterize the concept of decimation.

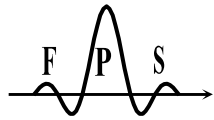

The sampling of the Fourier transform

- Sampling of the n-discrete Fourier transform
 - there is a *very* important relation between the Fourier series of a periodic discrete signal (in n) with period N , and the Fourier transform of an aperiodic discrete signal whose length is N :
 - sampling the Fourier transform of a discrete-time signal with length N , using N points uniformly distributed (with spacing $2\pi/N$) in the frequency between 0 and 2π , is equivalent to make $x[n]$ periodic with period N .
 - Example:

Represent the Fourier transform of $x[n]=1, 0 \leq n \leq 4$, and obtain the sequence $\tilde{x}[n]$ that results from sampling $X(e^{j\omega})$ uniformly in frequency using 10 points: $k2\pi/10, 0 \leq n \leq 9$.

A:

$$\boxed{x[n] = \begin{cases} 1, & 0 \leq n \leq 4 \\ 0, & \text{other} \end{cases}} \xleftrightarrow{\text{F}} \boxed{X(e^{j\omega}) = e^{-j2\omega} \cdot \frac{\sin(5\omega/2)}{\sin(\omega/2)}}$$

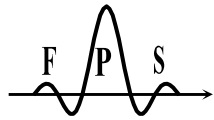

The sampling of the Fourier transform

sampling the Fourier transform we have:

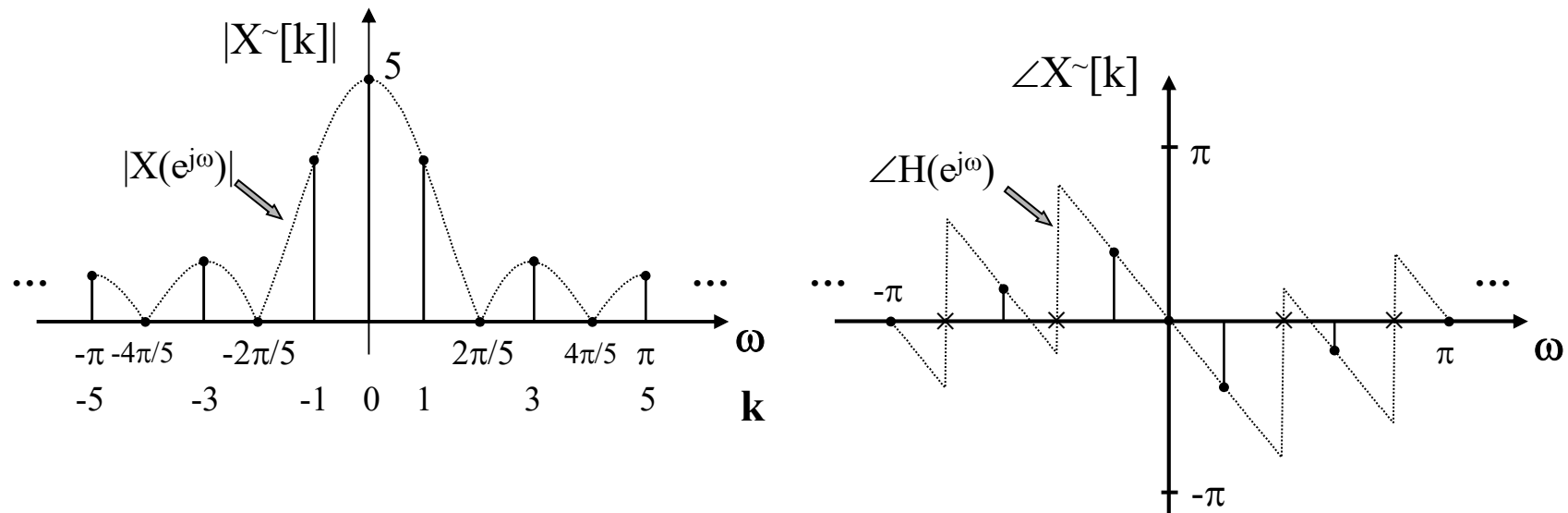

Note: the symbol \times in the phase representation means an undefined value since the magnitude is zero.

The sampling of the Fourier transform leads to:

$$\tilde{x}[n] = x[n] * \sum_{\ell=-\infty}^{+\infty} \delta[n-10\ell] = \sum_{\ell=-\infty}^{+\infty} x[n-10\ell]$$

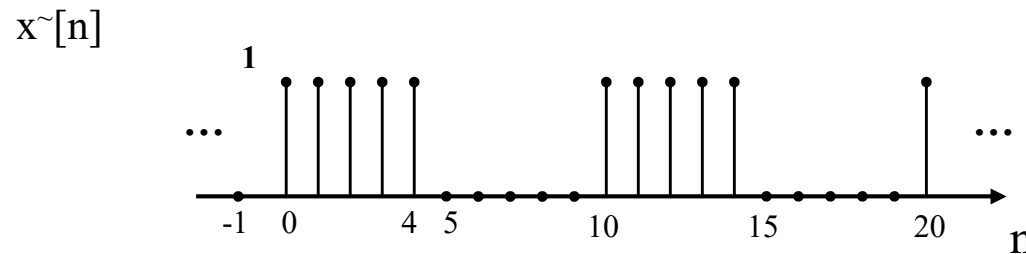

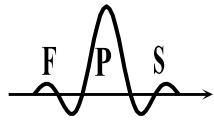

The sampling of the Fourier transform

- the result of the previous example may be presented in a more formal way. If $x[n]$ is an aperiodic sequence having Fourier transform $X(e^{j\omega})$, its sampling for $\omega=k2\pi/N$:

$$\tilde{X}[k] = X(e^{j\omega}) \Big|_{\omega=k\frac{2\pi}{N}} = X\left(e^{j\frac{2\pi}{N}k}\right)$$

gives rise to a sequence $\tilde{X}[k]$ that is periodic in k , with period N , that may alternatively be obtained using:

$$\tilde{X}[k] = X(Z) \Big|_{Z=e^{j\frac{2\pi}{N}k}} = X\left(e^{j\frac{2\pi}{N}k}\right)$$

The sequence $\tilde{X}[k]$ may be seen as the Fourier series of a periodic signal $\tilde{x}[n]$ which may be synthesized using a single period of $\tilde{X}[k]$:

$$\tilde{x}[n] = \frac{1}{N} \sum_{k=0}^{N-1} \tilde{X}[k] W_N^{-kn}$$

but since:

$$X(e^{j\omega}) = \sum_{m=-\infty}^{+\infty} x[m] e^{-j\omega m}$$

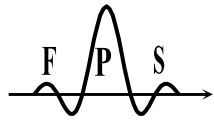

The sampling of the Fourier transform

then:
$$\tilde{x}[n] = \frac{1}{N} \sum_{k=0}^{N-1} \left[\sum_{m=-\infty}^{+\infty} x[m] e^{-j \frac{2\pi}{N} km} \right] W_N^{-kn} = \sum_{m=-\infty}^{+\infty} x[m] \left[\frac{1}{N} \sum_{k=0}^{N-1} W_N^{-k(n-m)} \right] = \sum_{m=-\infty}^{+\infty} x[m] \tilde{p}[n-m]$$

where:
$$\tilde{p}[n-m] = \frac{1}{N} \sum_{k=0}^{N-1} W_N^{-k(n-m)} = \frac{1}{N} \sum_{k=0}^{N-1} e^{jk \frac{2\pi}{N} (n-m)} = \begin{cases} 1, & n-m = \ell N \\ 0, & \text{other} \end{cases} \Leftrightarrow \sum_{\ell=-\infty}^{+\infty} \delta[n-m-\ell N]$$

and finally:
$$\tilde{x}[n] = x[n] * \tilde{p}[n] = x[n] * \sum_{\ell=-\infty}^{+\infty} \delta[n-\ell N] = \sum_{\ell=-\infty}^{+\infty} x[n-\ell N]$$

→ we conclude then that sampling the Fourier transform of an aperiodic signal $x[n]$, using N points uniformly distributed in $[0, 2\pi[$, gives rise to the superposition of an infinite number of shifted replicas of $x[n]$. There is however the risk that the superposition in n (“*aliasing* in time”) prevents $x[n]$ from being recognized in the periodic sequence, as the following example illustrates:

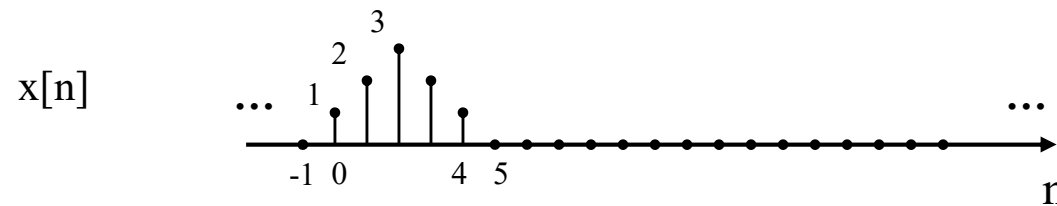

$$\sum_{\ell=-\infty}^{+\infty} x[n-6\ell]$$

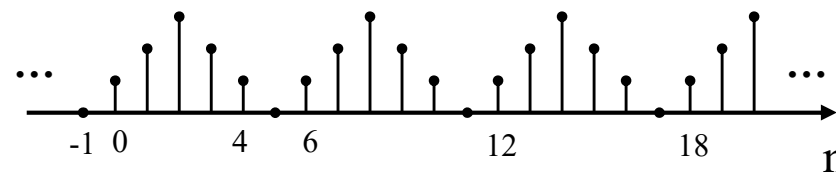

$$\sum_{\ell=-\infty}^{+\infty} x[n-4\ell]$$

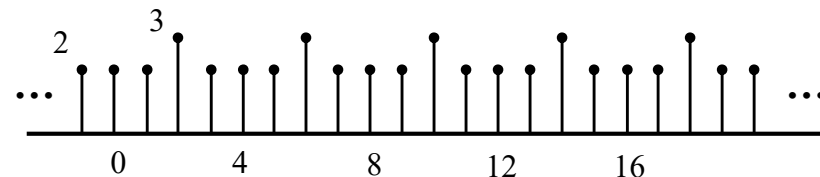

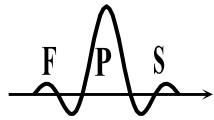

The sampling of the Fourier transform

- as a summary...
 - the important conclusion that can be extracted from the previous is that in order to recover $x[n]$ from the periodic sequence $\tilde{x}[n]$, it is necessary that the sampling of $X(e^{j\omega})$ be performed using a number of points N that is equal or greater than the length of $x[n]$.

- if this condition is satisfied, it is possible to recover $x[n]$ from $\tilde{x}[n]$:

$$x[n] = \begin{cases} \tilde{x}[n], & 0 \leq n \leq N-1 \\ 0, & \text{other} \end{cases}$$

- This discussion is reminiscent of the discussion relative to the uniform sampling of continuous signals:
 - taking a band-limited continuous signal $x_c(t)$, there is no loss of information if instead of being represented for all t (continuous), the signal is represented by the samples $x[n]=x_c(nT)$ taken uniformly in time,
- in similar terms, we may also conclude that:
 - taking a finite length $x[n]$ signal, there is no loss of information if instead of being represented for all ω (continuous), $X(e^{j\omega})$ is represented by N uniformly distributed samples in frequency, where N is equal or larger than the length of $x[n]$. This is the concept underlying the Discrete Fourier Transform (DFT) .

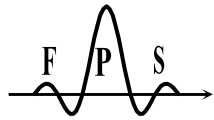

The Discrete Fourier Transform (DFT)

- Definition
 - consists in the representation of a finite-length discrete sequence, with $x[n] \neq 0$, for $0 \leq n \leq N-1$, by N values of $x[n]$ or, equivalently, by N values of its frequency-domain representation $X[k]$, on the basis of the implicit assumption that this discrete frequency representation corresponds, in fact, to the description of a periodic signal, one period of which corresponds to $x[n]$.

→ analysis equation of the DFT:
$$X[k] = \sum_{n=0}^{N-1} x[n] W_N^{kn}$$
 where:
$$W_N = e^{-j\frac{2\pi}{N}}$$

→ synthesis equation of the DFT:
$$x[n] = \frac{1}{N} \sum_{k=0}^{N-1} X[k] W_N^{-kn}$$

- this perspective is of great practical interest (why ?) but we should not forget that in reality and implicitly, we deal with $\tilde{x}[n]$ and with $\tilde{X}[k]$, and that we only consider (in order to simplify):

$$x[n] = \begin{cases} \tilde{x}[n], & 0 \leq n \leq N-1 \\ 0, & \text{other } n \end{cases}$$

$$X[k] = \begin{cases} \tilde{X}[k], & 0 \leq k \leq N-1 \\ 0, & \text{other } k \end{cases}$$

as a summary: periodicity is intrinsic to the definition of the DFT, which naturally constrains its properties.

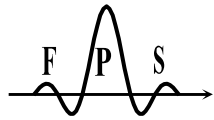

The Discrete Fourier Transform (DFT)

- Example: to compute the DFT sequence of length N of the following signal:

$$x[n] = \cos\left(n\ell \frac{2\pi}{N}\right), \quad 0 \leq n, \ell \leq N-1$$

A: it is easy to conclude that: $x[n] = \frac{1}{2} \left(e^{-j\frac{2\pi}{N}n\ell} + e^{j\frac{2\pi}{N}n\ell} \right) = \frac{1}{2} (W_N^{n\ell} + W_N^{-n\ell})$

and as: $X[k] = \sum_{n=0}^{N-1} x[n] W_N^{kn} = \frac{1}{2} \left[\sum_{n=0}^{N-1} W_N^{(k+\ell)n} + \sum_{n=0}^{N-1} W_N^{(k-\ell)n} \right]$

its value is N for $k+\ell=rN$, with r integer, but since $0 \leq k \leq N-1$, then there is only one possibility $\therefore k=N-\ell$.

it results that: $X[k] = \begin{cases} N/2, & k = \ell \\ N/2, & k = N - \ell \\ 0, & k \in [0, N-1] \setminus \{\ell, N-\ell\} \end{cases}$

NOTE: in this case, there is an alternative way to get to the same result: using the inverse DFT.

QUESTION: how to interpret the case where $\ell=0$?

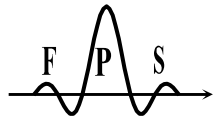

Properties of the DFT

- Linearity

$$\boxed{x_3[n] = ax_1[n] + bx_2[n]} \xleftrightarrow{F} \boxed{X_3[k] = aX_1[k] + bX_2[k]}$$

length of $x_1[n] \rightarrow N_1$

length of $x_2[n] \rightarrow N_2$

\therefore length of $x_3[n] \rightarrow N_3 = \text{MAX}(N_1, N_2)$

NOTE: the shortest sequence must be extended by appending zeroes (a process that is known as “zero-padding”) till it matches the length of the longer sequence, previously to the computation of the DFTs.

- Circular time shift

considering:

$$\boxed{x[n]} \xleftrightarrow{F} \boxed{X[k]}$$

we want to know:

$$\boxed{x_1[n]} = ? \xleftrightarrow{F} \boxed{e^{-j\frac{2\pi}{N}km} X[k]}$$

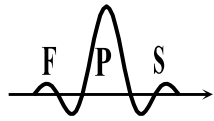

Properties of the DFT

if:
$$\tilde{x}[n] = \sum_{\ell=-\infty}^{+\infty} x[n - \ell N] = x([n \text{ modulo } N]) = x([n]_N)$$

and as we know that:

$$\tilde{x}_1[n] = \tilde{x}[n - m] \xleftrightarrow{F} \tilde{X}_1[k] = e^{-j\frac{2\pi}{N}km} \tilde{X}[k]$$

we conclude that:
$$x_1[n] = \begin{cases} \tilde{x}_1[n] = x([n - m]_N), & 0 \leq n \leq N - 1 \\ 0, & \text{other } n \end{cases}$$

where $x([n-m]_N)$ represents the circular shift of $x[n]$ as illustrated in the following example where $N=4$ and $m=2$:

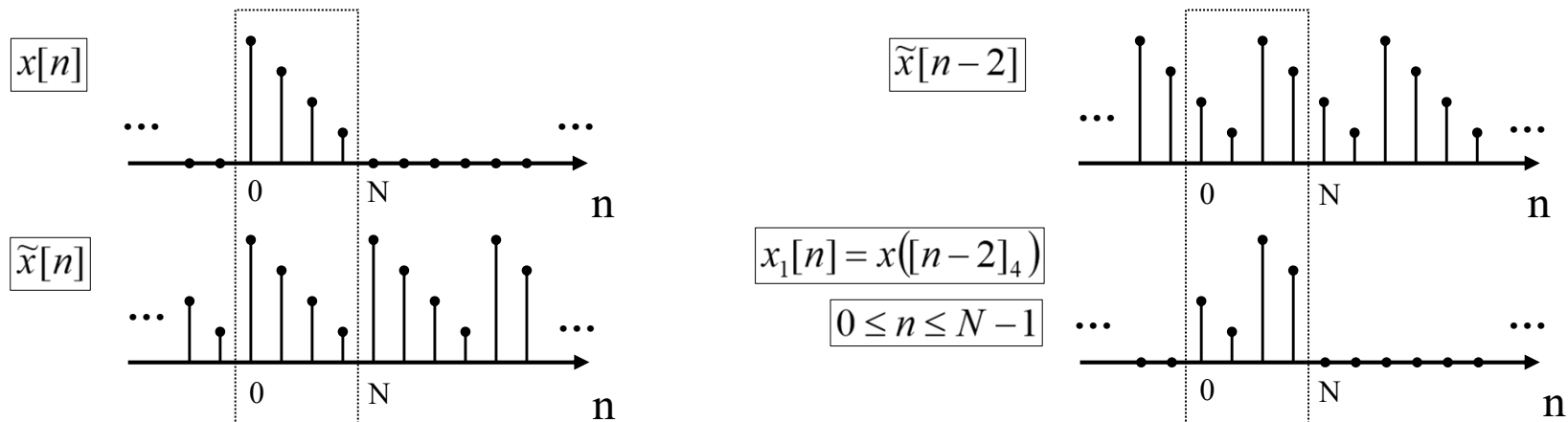

NOTE 1: given the nature of the circular shift, then:
$$x([n - \ell]_N) = x([n + (N - \ell)]_N)$$

since:
$$W_N^{k\ell} = W_N^{-k(N-\ell)}$$

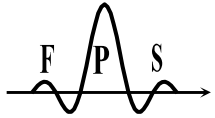

Properties of the DFT

NOTE 2: using a similar procedure, it can also be concluded that :

$$\boxed{e^{j\frac{2\pi}{N}n\ell} x[n]} \xleftrightarrow{\text{F}} \boxed{X([k-\ell]_N)}$$

- Duality

if:

$$\boxed{\tilde{x}[n]} \xleftrightarrow{\text{F}} \boxed{\tilde{X}[k]}$$

it results, considering the duality property of the Fourier series:

$$\boxed{\tilde{X}[n]} \xleftrightarrow{\text{F}} \boxed{N \tilde{x}[-k]}$$

and, therefore, if:

$$\boxed{x[n]} \xleftrightarrow{\text{F}} \boxed{X[k]}$$

it results also that:

$$\boxed{X[n]} \xleftrightarrow{\text{F}} \boxed{N x([-k]_N), \quad 0 \leq k \leq N-1}$$

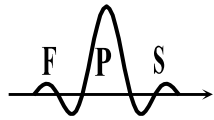

Properties of the DFT

- Symmetry

defining the following N-length sequences:

→ periodic conjugate-symmetric component:

$$x_{ep}[n] = \tilde{x}_e[n] = \frac{1}{2}(\tilde{x}[n] + \tilde{x}^*[-n]) = \frac{1}{2}(x[n] + x^*[N-n]), \quad 0 \leq n \leq N-1$$

→ periodic conjugate-antisymmetric component:

$$x_{op}[n] = \tilde{x}_o[n] = \frac{1}{2}(\tilde{x}[n] - \tilde{x}^*[-n]) = \frac{1}{2}(x[n] - x^*[N-n]), \quad 0 \leq n \leq N-1$$

it results: $x[n] = x_{ep}[n] + x_{op}[n]$

we may also conclude [Oppenheim, section 8.64]:

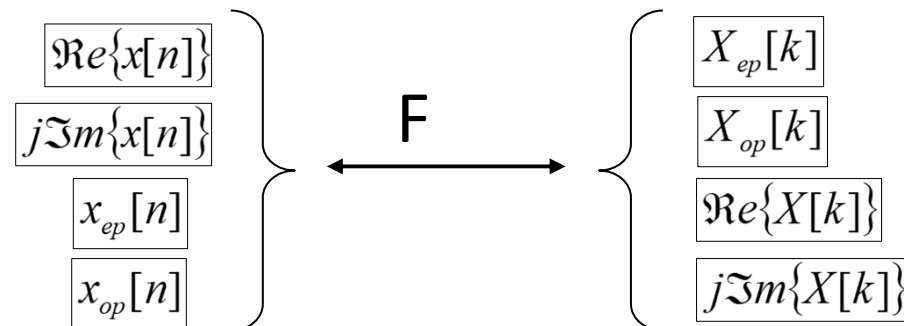

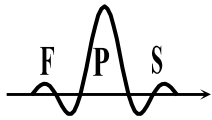

Properties of the DFT

NOTE : it is also easy to verify that:

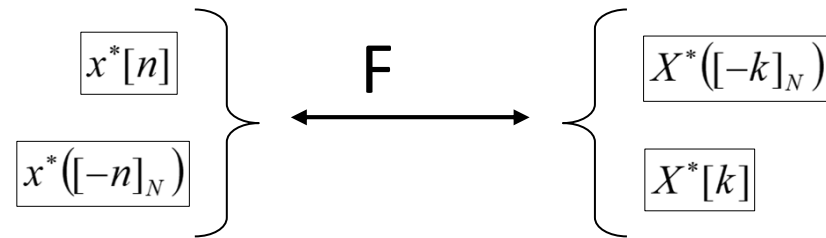

- Circular convolution

If $x_1[n]$ and $x_2[n]$ are two N-length sequences whose DFTs are $X_1[k]$ and $X_2[k]$, respectively, what is $x_3[n]$, the inverse DFT of the product $X_1[k]X_2[k]$?

A: Considering the periodic sequences $\tilde{x}_1[n] = x_1([n]_N)$ and $\tilde{x}_2[n] = x_2([n]_N)$ then:

$$\tilde{x}_3[n] = \tilde{x}_1[n] * \tilde{x}_2[n] = \sum_{\ell=0}^{N-1} \tilde{x}_1[\ell] \tilde{x}_2[n - \ell]$$

which is the periodic convolution.

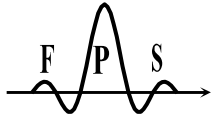

Properties of the DFT

Using this result it is also :

$$x_3[n] = \sum_{\ell=0}^{N-1} x_1([\ell]_N) x_2([n-\ell]_N), \quad 0 \leq n \leq N-1$$

which may be expressed as:

$$x_3[n] = \sum_{\ell=0}^{N-1} x_1[\ell] x_2([n-\ell]_N) = x_1[n] \otimes x_2[n], \quad 0 \leq n \leq N-1$$

The notation $x_1[n] \otimes x_2[n]$ is representative of the circular convolution because, in its computation, the second sequence is inverted in ℓ and is circularly shifted relative to the length of its period.

NOTE 1: differently from the linear convolution, the result of the circular convolution between two N-length sequences has length N.

NOTE 2: the circular convolution is also commutative and hence:

$$x_1[n] \otimes x_2[n] = x_2[n] \otimes x_1[n] = \sum_{\ell=0}^{N-1} x_2[\ell] x_1([n-\ell]_N), \quad 0 \leq n \leq N-1$$

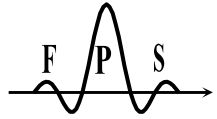

Properties of the DFT

- Example 1:

if: $x_1[n] = x_2[n] = \begin{cases} 1, & 0 \leq n \leq N-1 \\ 0, & \text{outros } n \end{cases}$ what is the result of $x_1[n] \otimes x_2[n]$?

A: as: $X_1[k] = X_2[k] = \sum_{n=0}^{N-1} W_N^{kn} = \begin{cases} N, & k = 0 \\ 0, & 1 \leq k \leq N-1 \end{cases}$

then: $X_3[k] = X_1[k]X_2[k] = \begin{cases} N^2, & k = 0 \\ 0, & 1 \leq k \leq N-1 \end{cases} \xleftrightarrow{F} x_3[n] = N, \quad 0 \leq n \leq N-1$

graphically we have (e.g., N=4):

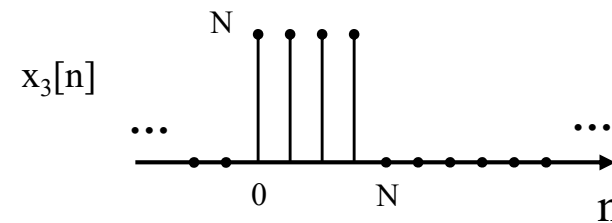
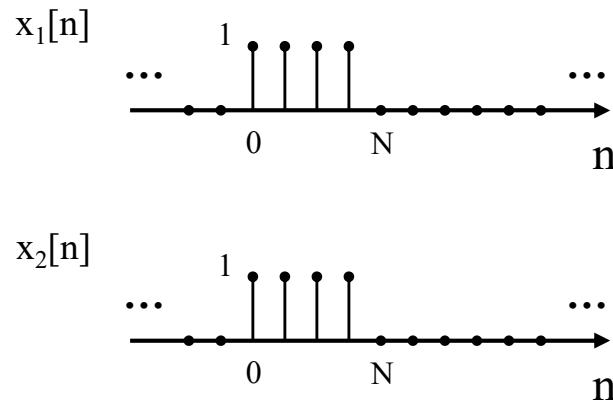

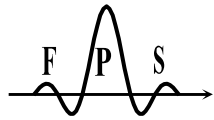

Properties of the DFT

- Example 2:

$$\text{If: } x_1[n] = x_2[n] = \begin{cases} 1, & 0 \leq n \leq L-1 \\ 0, & L \leq n \leq N-1 \cup n < 0 \cup n > N \end{cases}$$

what is the result of $x_1[n] \otimes x_2[n]$?

$$\text{A: as: } X_1[k] = X_2[k] = \sum_{n=0}^{L-1} W_N^{kn} = \frac{1 - W_N^{kL}}{1 - W_N^k}$$

$$\text{then: } X_3[k] = X_1[k]X_2[k] = \left(\frac{1 - W_N^{kL}}{1 - W_N^k} \right)^2$$

admitting $N=10$ and $L=4$, graphically we have:

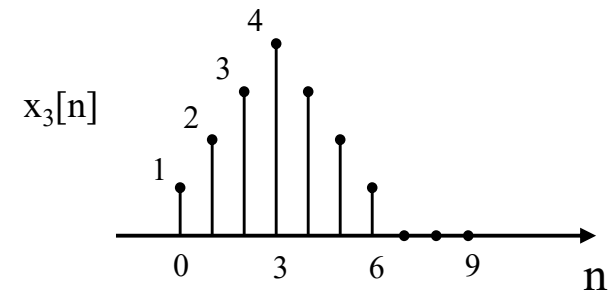
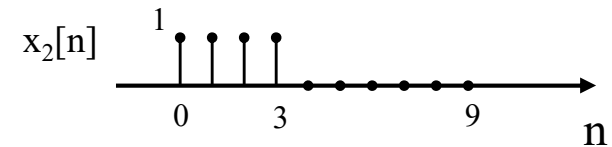
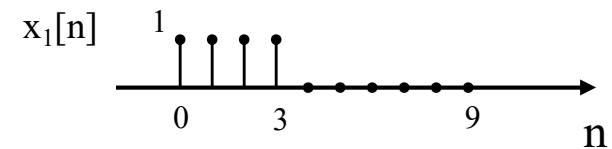

Question 1: May we state that in this example the result of the circular convolution is the same as that of the linear convolution ?

Question 2: Keeping $L=4$, what is the minimum value of N that leads to the same result ?

Question 3: May we state that we may use the circular convolution to compute the linear convolution ?
If yes, under which conditions ?

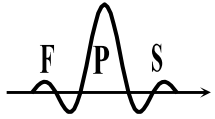

Properties of the DFT

- It can also be shown that:

$$\boxed{x_1[n] \cdot x_2[n]} \xleftrightarrow{\text{F}} \boxed{\frac{1}{N} X_1[k] \otimes X_2[k] = \frac{1}{N} \sum_{\ell=0}^{N-1} X_1[\ell] X_2([k - \ell]_N)}$$