

Summary

- *The Z-Transform*
 - *Definition*
 - *Region of convergence (RC)*
 - *Properties of the RC*
 - *Implications of stability and causality in the RC*
 - *A few important Z-Transform pairs*
 - *The inverse Z-Transform*
 - *A few properties of the Z-Transform*
- *The Z-Transform of the auto/cross-correlation*
 - *the Z-Transform of the auto-correlation*
 - *the Z-Transform of the cross-correlation*

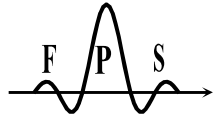

The Z-Transform

- consists in a generalization of the Fourier transform for discrete signals
 - allows to represent signals whose Fourier transform does not converge
- is equivalent to the Laplace transform for continuous-time signals
- simplifies the notation in the analysis of problems (e.g. interpolation or decimation)

- Definition

$$Z\{x[n]\} = X(z) = \sum_{n=-\infty}^{+\infty} x[n]Z^{-n}, \quad Z = re^{j\omega}$$

where Z is a continuous complex variable, we represent symbolically:

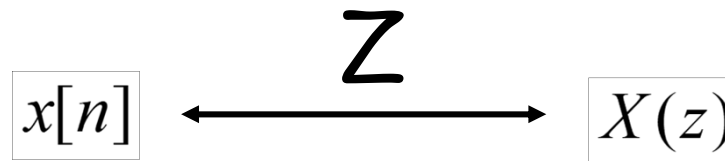

NOTE: the Z transform of $x[n]$ is the Fourier transform of the signal $x[n]r^{-n}$, such that when $r=1$, a Z transform reduces to the Fourier transform:

$$X(z) = \sum_{n=-\infty}^{+\infty} x[n]Z^{-n} = \sum_{n=-\infty}^{+\infty} x[n](re^{j\omega})^{-n} = \sum_{n=-\infty}^{+\infty} [x[n]r^{-n}]e^{-j\omega n} = F\{x[n]r^{-n}\}$$

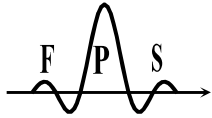

The Z-Transform

- Plane of the Z complex variable

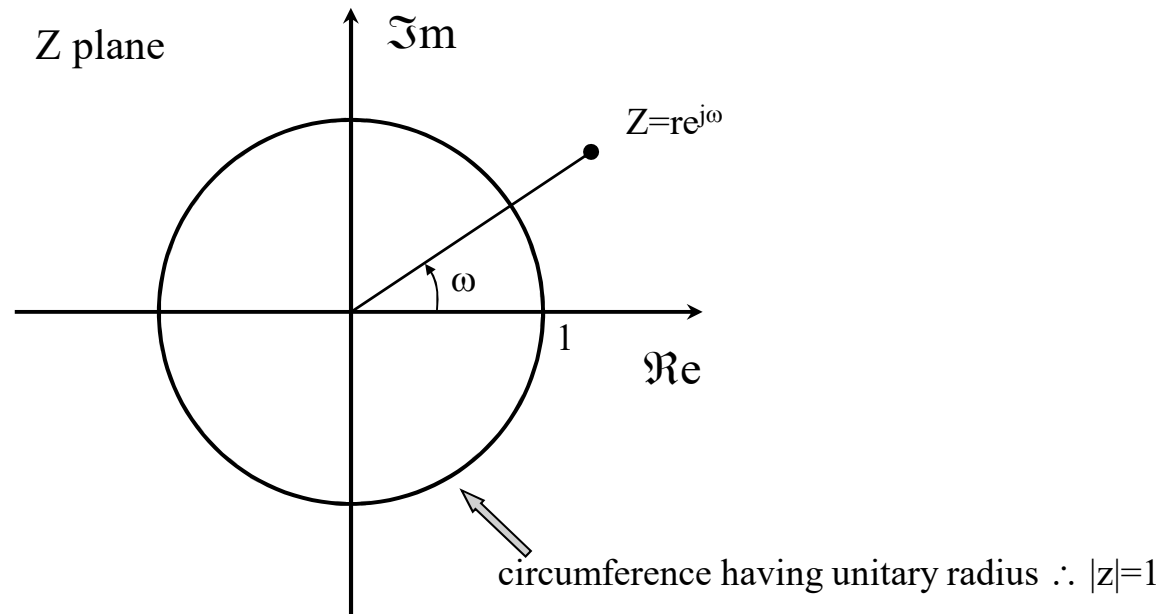

- **particularity 1:** the Fourier transform corresponds to the evaluation of the Z transform on the unit circumference
- **particularity 2:** the 2π periodicity that characterizes the representation of a discrete signal in the frequency domain, is intrinsic to the Z plane

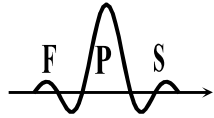

The region of convergence of the Z-Transform

- Region of convergence
 - given a discrete sequence $x[n]$, the set of Z values for which the Z transform converges (*i.e.* the infinite summation of power values converges to a finite result) is known as the region of convergence (RoC or RC)
 - the condition to be verified, as in the case of the Fourier transform, is that the sequence of powers of the Z transform is absolutely summable:

$$\sum_{n=-\infty}^{+\infty} |x[n]Z^{-n}| = \sum_{n=-\infty}^{+\infty} |x[n]| |Z^{-n}| = \sum_{n=-\infty}^{+\infty} |x[n]| |r|^{-n} < \infty$$

- from the previous it can be concluded that if Z_1 belongs to the region of convergence, then any Z_2 such that $|Z_1| = |Z_2|$, also belongs to the region of convergence, and hence the RC has always the shape of a ring in the Z plane and centered at the origin of this plane.

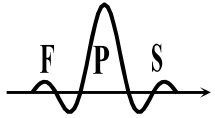

The region of convergence of the Z-Transform

- from the previous it results that three possibilities may occur for the RC:

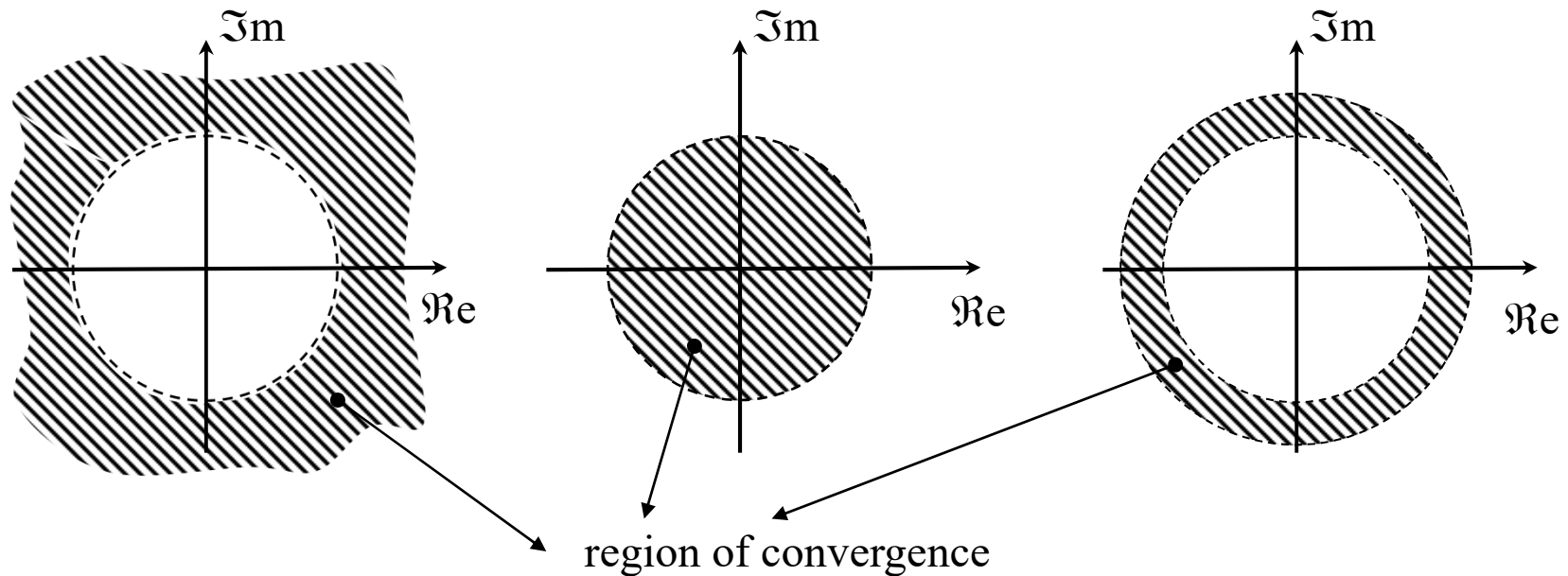

- NOTE: if the region of convergence associated with the Z transform of a discrete-time sequence includes the unit circumference, then it can be concluded that the Fourier transform exists (*i.e.* converges) for that sequence. Inversely, ...

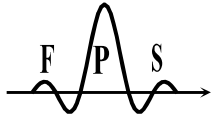

Properties of the RC of the Z-Transform

- the most common and useful way to express mathematically the Z transform of a sequence, using a closed-form expression (*i.e.* using a compact expression), is by means of a rational function:

$$X(z) = \frac{P(z)}{Q(z)}$$

where $P(z)$ and $Q(z)$ are Z polynomials. The finite roots of $P(z)$ are the ZEROES of the Z transform (usually identified by the symbol “o” in the Z plane) and the finite roots of $Q(z)$ are the POLES of the Z transform (*i.e.* they make that $X(z)$ be infinite and they are usually identified by the symbol “x” in the Z plane) . It may however happen that zeroes or poles appear at $z=0$ (visible) or at $z=\infty$ (not visible).

Taking into consideration the previous ideas, we define the following:

- Properties of the region of convergence (RC)
 1. the RC is a disc or ring in the Z plane and centered at the origin,
 2. the RC is a connected region (*i.e.* it is not the combination of disjoint regions),

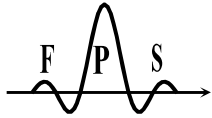

Properties of the RC of the Z-Transform

3. the RC may not contain poles inside,
4. if $x[n]$ is a finite-duration sequence (*i.e.* a sequence that is different from zero for $-\infty < N_1 < n < N_2 < +\infty$) then the RC is the entire Z plane, except possibly for $z=0$ or for $z=\infty$,
5. if $x[n]$ is a right-hand sided sequence (*i.e.* a sequence that is different from zero for $n > N_1 > -\infty$), then the RC extends to the outside of a circumference defined by the finite pole that is more distant from the origin of the Z plane,
6. if $x[n]$ is a left-hand sided sequence (*i.e.* a sequence that is different from zero for $n < N_2 < +\infty$), then the RC extends to the inside of a circumference defined by the finite pole that is closest to the origin of the Z plane,
7. if $x[n]$ is neither right-hand sided nor left-hand sided (*i.e.*, it is a two-sided sequence), then the RC, if it exists, consists in a ring (that may not contain poles inside !), that is bounded by two circumferences defined by two finite poles,
8. the Fourier transform of a sequence $x[n]$ converges absolutely if and only if the RC of its Z transform includes the unit circumference.

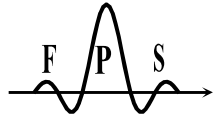

example 1

$$x[n] = a^n u[n] \xleftrightarrow{Z} X(z) = \sum_{n=0}^{+\infty} a^n Z^{-n} = \sum_{n=0}^{+\infty} (aZ^{-1})^n = \frac{1}{1 - aZ^{-1}} \quad , \text{if } |aZ^{-1}| < 1 \therefore |Z| > |a|$$

where RC $\equiv |z| > |a|$

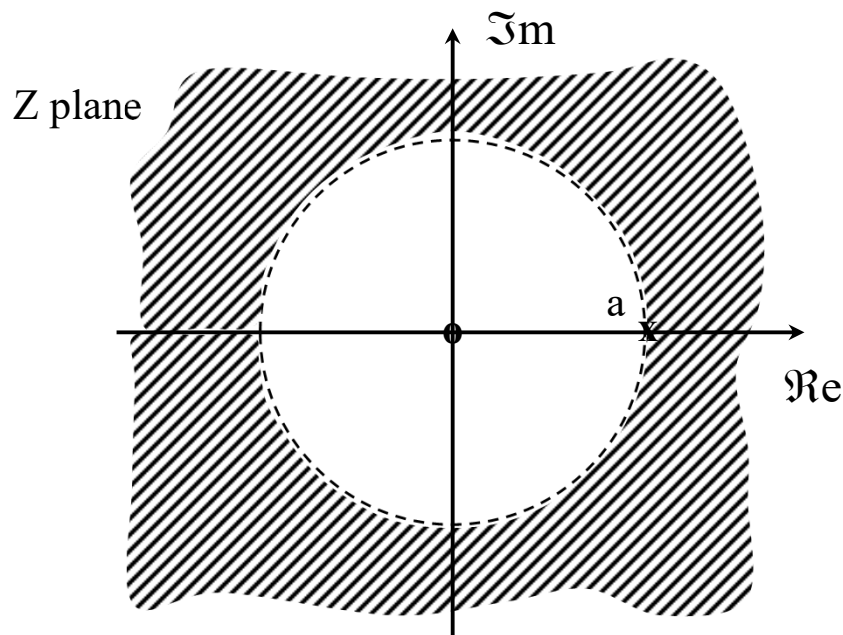

(admitting a is real and positive)

NOTE 1: if $|a| < 1$, then the Fourier transform of the sequence $x[n]$ exists

NOTE 2: this example includes, as a particular case, the unit step (that is not absolutely summable nor square summable, but whose Fourier transform exists using discontinuous and non-differentiable functions: pulses)

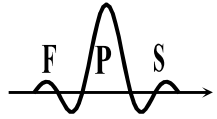

example 2

$$x[n] = -a^n u[-n-1] \xleftrightarrow{Z} X(z) = -\sum_{n=-\infty}^{-1} a^n Z^{-n} = -\sum_{n=-\infty}^{-1} (aZ^{-1})^n = 1 - \sum_{n=0}^{+\infty} (a^{-1}Z)^n = 1 - \frac{1}{1-a^{-1}Z} = \frac{1}{1-aZ^{-1}} \quad , \text{if } |a^{-1}Z| < 1 \therefore |Z| < |a|$$

where RC $\equiv |z| < |a|$

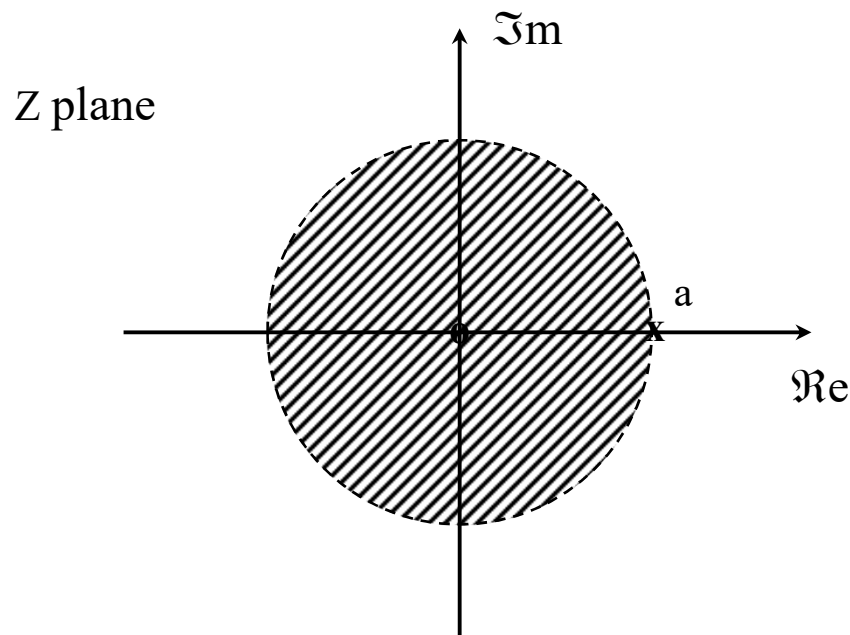

(admitting a is real and positive)

NOTE : if $|a| > 1$, then the Fourier transform of the sequence $x[n]$ exists

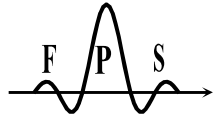

wrap-up

- the previous two examples reveal that the Z function defining the poles and the zeroes of the Z transform of a signal is insufficient to characterize it: it is always necessary to specify the associated region of convergence (RC)
- in case $x[n]$ consists of several terms, each one having its own RC, then the combined RC is the intersection among all RCs, *i.e.* the one making simultaneously valid the convergence of the different sums of Z powers, as the following example illustrates.

example 3

$$x[n] = \left(\frac{1}{2}\right)^n u[n] + \left(-\frac{1}{3}\right)^n u[n]$$



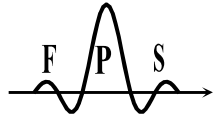

as:

$$\left. \begin{array}{l} \left(\frac{1}{2}\right)^n u[n] \\ \left(-\frac{1}{3}\right)^n u[n] \end{array} \right\} \xleftrightarrow{\mathbf{Z}} \left\{ \begin{array}{l} \frac{1}{1 - \frac{1}{2}Z^{-1}}, |Z| > \frac{1}{2} \\ \frac{1}{1 + \frac{1}{3}Z^{-1}}, |Z| > \frac{1}{3} \end{array} \right.$$

and given the linearity of the Z transform:

$$\left(\frac{1}{2}\right)^n u[n] + \left(-\frac{1}{3}\right)^n u[n] \xleftrightarrow{\mathbf{Z}} \frac{1}{1 - \frac{1}{2}Z^{-1}} + \frac{1}{1 + \frac{1}{3}Z^{-1}} = \frac{2\left(1 - \frac{1}{12}Z^{-1}\right)}{\left(1 - \frac{1}{2}Z^{-1}\right)\left(1 + \frac{1}{3}Z^{-1}\right)} = \frac{2Z\left(Z - \frac{1}{12}\right)}{\left(Z - \frac{1}{2}\right)\left(Z + \frac{1}{3}\right)}, |Z| > \frac{1}{2} \cap |Z| > \frac{1}{3} \equiv |Z| > \frac{1}{2}$$

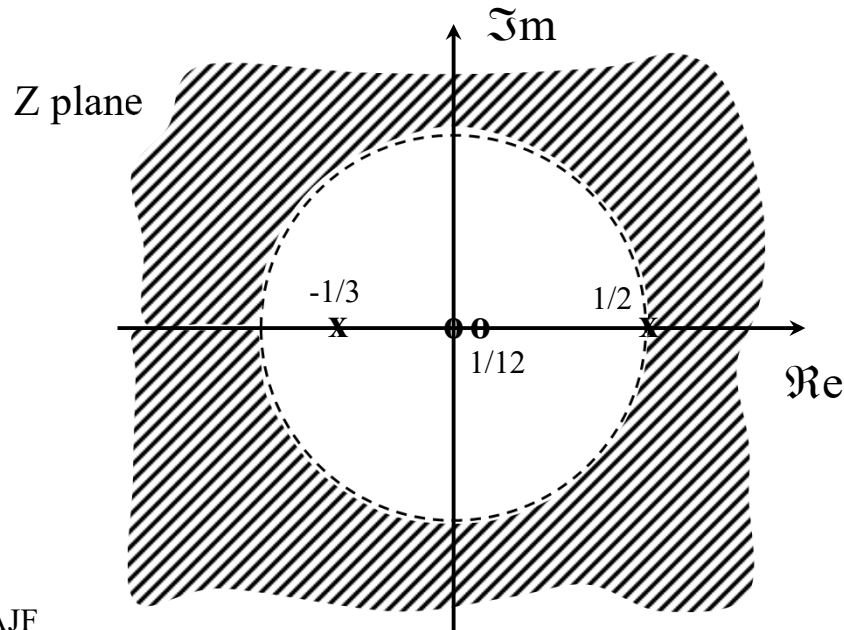

QUESTION : what would be the RC if $x[n] = (-1/3)^n u[n] - (1/2)^n u[-n-1]$?

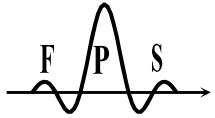

example 4

$$x[n] = \begin{cases} a^n & , 0 \leq n \leq N-1 \\ 0 & \text{other} \end{cases} \xleftrightarrow{Z} X(z) = \sum_{n=0}^{N-1} a^n Z^{-n} = \sum_{n=0}^{N-1} (aZ^{-1})^n = \frac{1 - (aZ^{-1})^N}{1 - aZ^{-1}} = \frac{1}{Z^{N-1}} \frac{Z^N - a^N}{Z - a}, \forall Z \setminus \{Z = 0\}$$

NOTE 1: the roots of the numerator (zeroes) are given by $Z_k = ae^{jk2\pi/N}$, $0 \leq k \leq N-1$

NOTE 2: the pole at $Z=a$ is cancelled out by the zero at the same location,

NOTE 3: as long as $|aZ^{-1}|$ is finite $\Leftrightarrow |a| < \infty$ and $Z \neq 0$, this case does not imply convergence difficulties and, as a result, the RC is the entire Z plane except $Z=0$,

NOTE 4: if $N=8$, the distribution of poles and zeroes in the Z plane is:

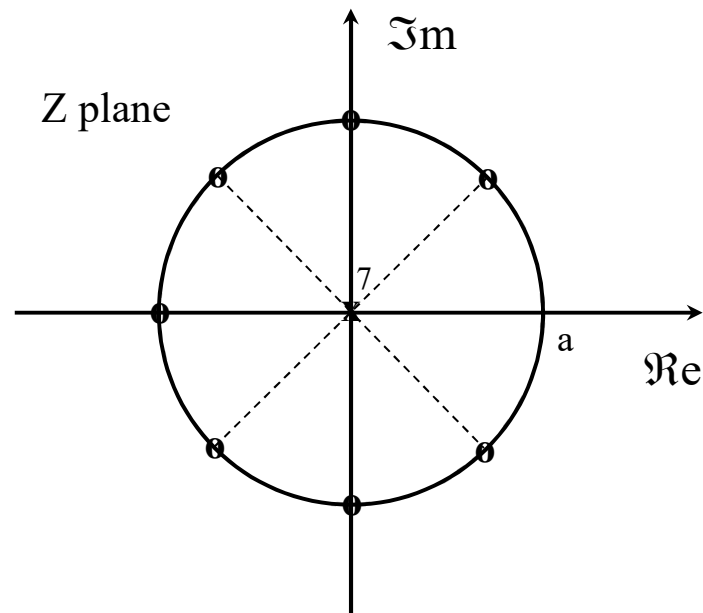

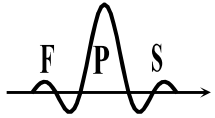

Implications of stability and causality in the RC

1. If a system having impulse response $h[n]$ [whose Z transform is $H(z)$] is stable (i.e. $h[n]$ is absolutely summable and, thus, has a Fourier transform), then the RC associated with $H(z)$ must include the unit circumference
2. If a system having impulse response $h[n]$ is causal, then $h[n]$ is a right-hand sided sequence and the RC associated with its Z transform, $H(z)$, must extend to the outside of a circumference defined by the finite pole that is more far way from the origin of the Z plane.

Question: which of the following zero-pole diagrams may correspond to a discrete system that is simultaneously stable and causal ?

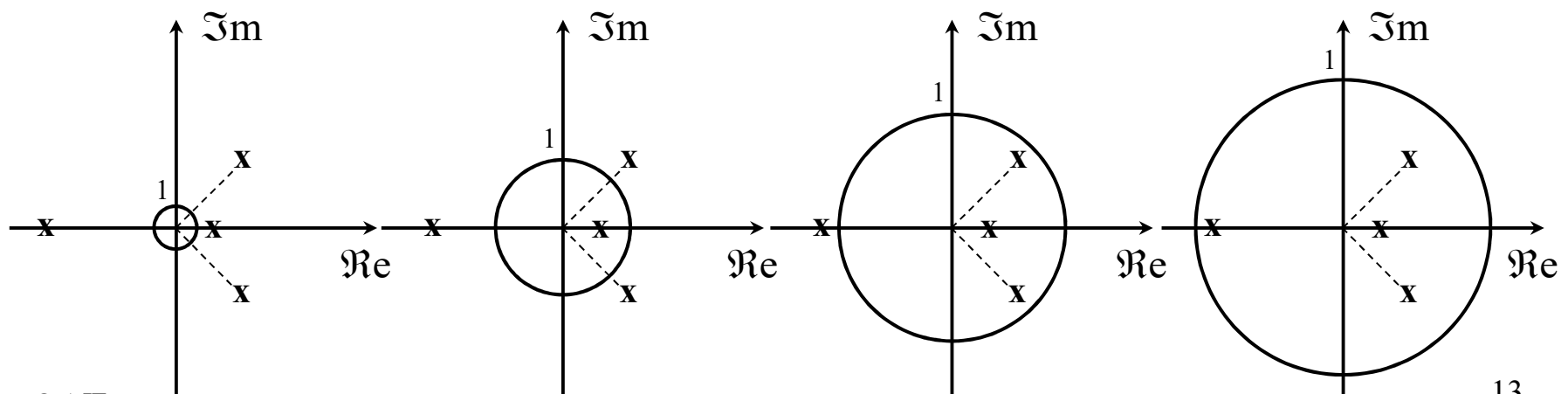

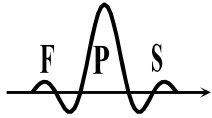

A few important Z-Transform pairs

(useful to evaluate either the direct Z-Transform or the inverse Z-Transform !)

$x[n]$	$X(z)$	RC
$\delta[n]$	1	<ul style="list-style-type: none"> • entire Z plane • entire Z plane except $Z=0$ (if $n_0 > 0$) or except $Z=\infty$ (if $n_0 < 0$) • $z > 1$ • $z < 1$ • $z > a$ • $z < a$ • $z > a$ • $z < a$ • $z > 1$ • $z > 1$ • $z > r$ • $z > r$
$\delta[n - n_0]$	Z^{-n_0}	
$u[n]$	$\frac{1}{1 - Z^{-1}}$	
$-u[-n - 1]$	$\frac{1}{1 - Z^{-1}}$	
$a^n u[n]$	$\frac{1}{1 - aZ^{-1}}$	
$-a^n u[-n - 1]$	$\frac{1}{1 - aZ^{-1}}$	
$na^n u[n]$	$\frac{aZ^{-1}}{(1 - aZ^{-1})^2}$	
$-na^n u[-n - 1]$	$\frac{aZ^{-1}}{(1 - aZ^{-1})^2}$	
$(\cos \omega_0 n) u[n]$	$\frac{1 - \cos \omega_0 Z^{-1}}{1 - 2 \cos \omega_0 Z^{-1} + Z^{-2}}$	
$(\sin \omega_0 n) u[n]$	$\frac{\sin \omega_0 Z^{-1}}{1 - 2 \cos \omega_0 Z^{-1} + Z^{-2}}$	
$(r^n \cos \omega_0 n) u[n]$	$\frac{1 - r \cos \omega_0 Z^{-1}}{1 - 2r \cos \omega_0 Z^{-1} + r^2 Z^{-2}}$	
$(r^n \sin \omega_0 n) u[n]$	$\frac{r \sin \omega_0 Z^{-1}}{1 - 2r \cos \omega_0 Z^{-1} + r^2 Z^{-2}}$	

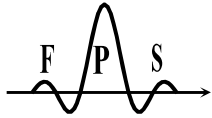

The inverse Z-Transform

frequent path in the analysis/project/modification of signals or discrete systems:

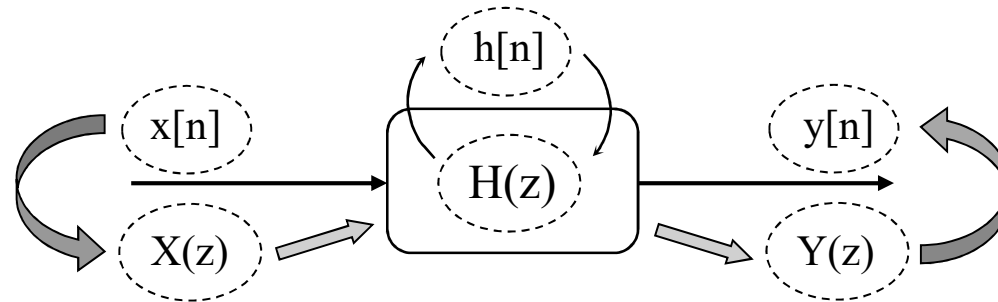

the computation of the inverse Z transform is thus necessary and frequent.

- Method 1: by inspection

Involves the identification and direct use of known pairs of the Z transform from a table such as that of the previous slide; in order to take full advantage of this method, it is convenient to decompose the Z function (whose inverse we want to find) as a sum of simple Z functions (e.g., first order functions), such that, for each one, the corresponding Z transform pair is readily identified.

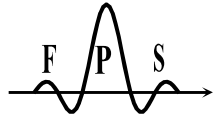

The inverse Z-Transform

- Method 2: partial fraction expansion

if $X(z)$ is expressed as a ratio of Z polynomials:

$$X(z) = \frac{\sum_{k=0}^M b_k Z^{-k}}{\sum_{\ell=0}^N a_{\ell} Z^{-\ell}}$$

the number of poles is equal to the number of zeroes and all may be represented in the “finite” Z plane (*i.e.* there are no zeroes or poles at $z=\infty$), hence it is possible to express $X(z)$ as a sum of partial fractions, each one associated to a pole of $X(z)$:

$$X(z) = \frac{b_0 \prod_{k=1}^M (1 - c_k Z^{-1})}{a_0 \prod_{\ell=1}^N (1 - d_{\ell} Z^{-1})}$$

where c_k are the non-zero zeroes of $X(z)$ and d_{ℓ} are the non-zero poles of $X(z)$.

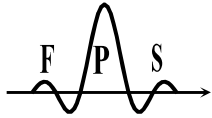

The inverse Z-Transform

If $X(z)$ is presented in an irreducible form, *i.e.* if $M < N$ **and** all poles are first order (*i.e.* their multiplicity is 1), then $X(z)$ may be written as:

$$X(z) = \sum_{k=1}^N \frac{A_k}{1 - d_k Z^{-1}}$$

where the constants A_k are obtained as:

$$A_k = \left(1 - d_k Z^{-1}\right) X(z) \Big|_{Z=d_k}$$

Finding the inverse Z transform is now straightforward. That is also the case when $M \geq N$ after dividing the numerator by the denominator, the order of the numerator of the remainder must be less than N and $X(z)$ may be expressed as:

$$X(z) = \sum_{\ell=0}^{M-N} B_{\ell} Z^{-\ell} + \sum_{k=1}^N \frac{A_k}{1 - d_k Z^{-1}}$$

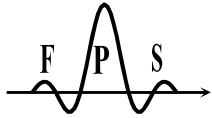

The inverse Z-Transform

If there are poles whose multiplicity is higher than 1, a more complex approach has to be followed; for example, if a pole exists at d_i whose multiplicity is m then, presuming all other poles are first-order, $X(z)$ may be expressed as:

$$X(z) = \sum_{s=0}^{M-N} B_s Z^{-s} + \sum_{\substack{k=1 \\ k \neq i}}^N \frac{A_k}{1 - d_k Z^{-1}} + \sum_{\ell=1}^m \frac{C_\ell}{(1 - d_i Z^{-1})^\ell}$$

where the constants C_ℓ are obtained as:

$$C_\ell = \frac{1}{(m - \ell)! (-d_i)^{m - \ell}} \left\{ \frac{\partial^{m - \ell}}{\partial w^{m - \ell}} \left[(1 - d_i w)^m X(w^{-1}) \right] \right\}_{w = d_i^{-1}}$$

After the decomposition of $X(z)$ as partial fractions, $x[n]$ may be evaluated as the inverse Z transform of each partial fraction and taking into consideration the linearity of the Z transform. The identification of the causal or anti-causal behavior of each partial fraction results by analyzing the regions of convergence.

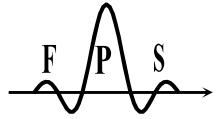

Example

$$X(z) = \frac{1}{\left(1 - \frac{1}{4}Z^{-1}\right)\left(1 - \frac{1}{2}Z^{-1}\right)}, \quad |z| > \frac{1}{2}$$

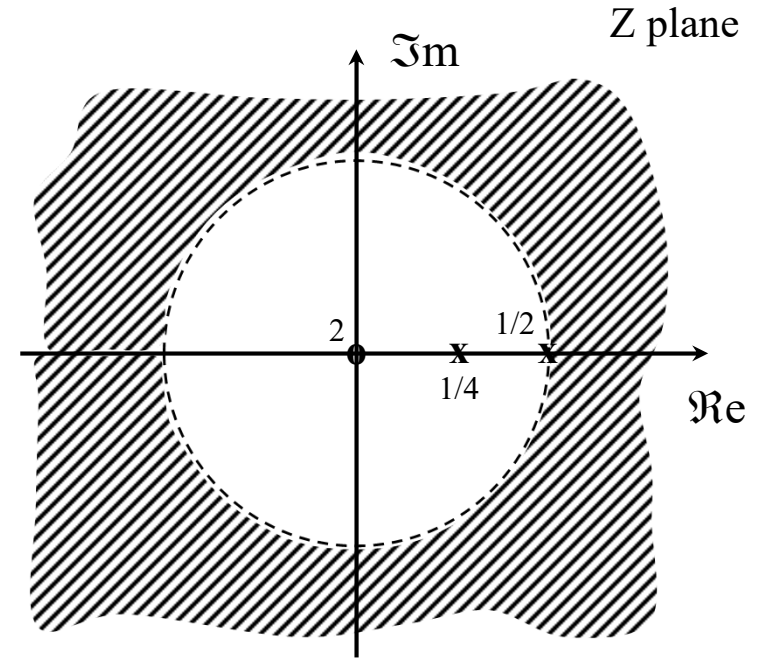
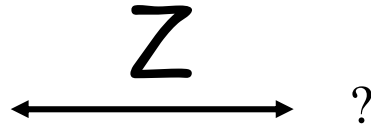

Then:

$$X(z) = \frac{A}{1 - \frac{1}{4}Z^{-1}} + \frac{B}{1 - \frac{1}{2}Z^{-1}}$$

where:

$$A = \left(1 - \frac{1}{4}Z^{-1}\right)X(z) \Big|_{z=\frac{1}{4}} = -1 \quad \text{and} \quad B = \left(1 - \frac{1}{2}Z^{-1}\right)X(z) \Big|_{z=\frac{1}{2}} = 2$$

resulting:

$$X(z) = \frac{2}{1 - \frac{1}{2}Z^{-1}} - \frac{1}{1 - \frac{1}{4}Z^{-1}}$$

and by analyzing the region of convergence, one

concludes that the two poles are associated to right-hand sided sequences, which gives rise to:

$$x[n] = 2\left(\frac{1}{2}\right)^n u[n] - \left(\frac{1}{4}\right)^n u[n]$$

↑ ↑
not to forget !

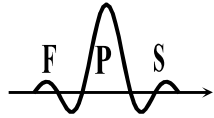

The inverse Z-Transform

- Method 3: contour integral

Taking advantage of the Cauchy integral theorem which states that:

$$\frac{1}{2\pi j} \oint_C Z^{k-1-\ell} dZ = \begin{cases} 1 & , k = \ell \\ 0 & , k \neq \ell \end{cases}$$

(particular case: $\ell=0$) where C is a counter-clockwise contour that includes the origin of the Z plane, one may conclude [Oppenheim, 1975] that it is possible to find $x[n]$ using the contour integral:

$$x[n] = \frac{1}{2\pi j} \oint_C X(z) Z^{n-1} dZ$$

where C is a counter-clockwise contour inside the RC [Sanjit Mitra, 2006].

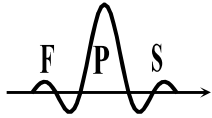

The inverse Z-Transform

The advantage of this formulation is that for rational functions, it may be conveniently replaced by the computation of the residue theorem:

$$x[n] = \frac{1}{2\pi j} \oint_C X(z)Z^{n-1} dZ = \sum [\text{residues of } X(z)Z^{n-1}, \text{ at the poles inside } C]$$

where the residue for a pole at $Z=Z_0$ and having multiplicity m is given by:

$$\text{Residue} [X(z)Z^{n-1} \text{ at } Z = Z_0] = \frac{1}{(m-1)!} \cdot \frac{d^{m-1}}{dz^{m-1}} [(Z - Z_0)^m X(z)Z^{n-1}] \Big|_{z=z_0}$$

NOTE 1: in case of a single pole at $Z=Z_0$ the corresponding residue is:

$$\text{Residue} [X(z)Z^{n-1} \text{ at } Z = Z_0] = (Z - Z_0)X(z)Z^{n-1} \Big|_{z=z_0}$$

NOTE 2: the utilization of this method for $n < 0$ may be problematic since a pole at $z=0$ and having multiplicity > 1 may appear. As an alternative, it may be preferable to use other methods.

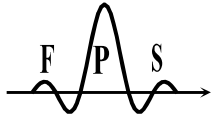

The inverse Z-Transform

- EXAMPLE**

$$X(z) = \frac{1}{\left(1 - \frac{1}{4}Z^{-1}\right)\left(1 - \frac{1}{2}Z^{-1}\right)}, \quad |z| > \frac{1}{2}$$

we have: $X(z)Z^{n-1} = \frac{Z^{n-1}}{\left(1 - \frac{1}{4}Z^{-1}\right)\left(1 - \frac{1}{2}Z^{-1}\right)} = \frac{Z^{n+1}}{\left(Z - \frac{1}{4}\right)\left(Z - \frac{1}{2}\right)}$

and thus:

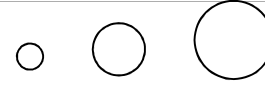

Z

← → ?

QUESTION: how to proceed if, presuming causality, $X(z)Z^{n-1}$ was:

$$\frac{Z^{n-1}}{\left(Z - \frac{1}{4}\right)\left(Z - \frac{1}{2}\right)}$$

?

Residue at $z = \frac{1}{4}$: $\left(Z - \frac{1}{4}\right)X(z)Z^{n-1} \Big|_{z=\frac{1}{4}} = \frac{\left(\frac{1}{4}\right)^{n+1}}{\frac{1}{4} - \frac{1}{2}} = -\left(\frac{1}{4}\right)^n, \quad n \geq 0$

Residue at $z = \frac{1}{2}$: $\left(Z - \frac{1}{2}\right)X(z)Z^{n-1} \Big|_{z=\frac{1}{2}} = \frac{\left(\frac{1}{2}\right)^{n+1}}{\frac{1}{2} - \frac{1}{4}} = 2\left(\frac{1}{2}\right)^n, \quad n \geq 0$

from which we conclude:

$$x[n] = \left[2\left(\frac{1}{2}\right)^n - \left(\frac{1}{4}\right)^n \right] u[n]$$

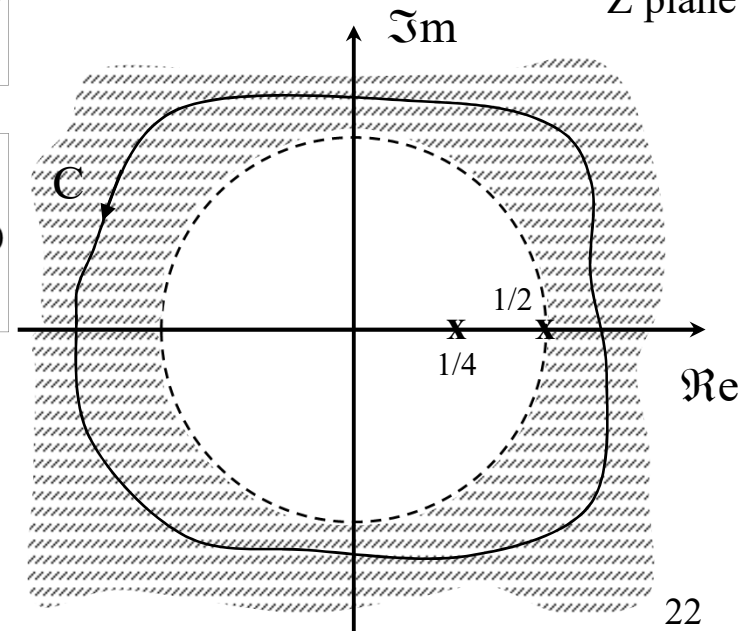

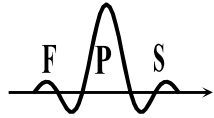

Properties of the Z-Transform

- Properties are very useful in the analysis and project of discrete-time signals and systems (allowing for example a direct connection between a difference equation describing a system and the Z transform of its impulse response).

taking: $x[n]$ \xleftrightarrow{Z} $X(z)$, with $RC = R_X \equiv r_E < |Z| < r_D$

and also: $\left. \begin{matrix} x_1[n] \\ x_2[n] \end{matrix} \right\} \xleftrightarrow{Z} \left\{ \begin{matrix} X_1(z) , \text{ with } RC = R_{X1} \\ X_2(z) , \text{ with } RC = R_{X2} \end{matrix} \right.$

we have:

- **Linearity**

$$ax_1[n] + bx_2[n] \xleftrightarrow{Z} aX_1(z) + bX_2(z) , \text{ with } RC = R_{X1} \cap R_{X2}$$

NOTE: a linear combination may give rise to a pole-zero cancellation and hence the final RC may be larger than R_{X1} and R_{X2} , for example:

$$x[n] = a^n u[n] - a^n u[n-N] \quad \text{but the final RC is } |Z| > 0 .$$

$$\begin{matrix} \uparrow & \uparrow \\ RC_1 \equiv |Z| > |a| & RC_2 \equiv |Z| > |a| \end{matrix}$$

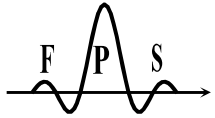

Properties of the Z-Transform

- Displacement in n

$$x[n - n_0] \xleftrightarrow{Z} Z^{-n_0} X(z), \quad RC = R_X \text{ (except for possible insertion/deletion of } z = 0 \text{ or } z = \infty)$$

example:

$$X(z) = \frac{1}{Z - \frac{1}{4}} = \frac{Z^{-1}}{1 - \frac{1}{4}Z^{-1}} = -4 + \frac{4}{1 - \frac{1}{4}Z^{-1}}$$

$$RC \equiv |Z| > \frac{1}{4}$$

$$\xleftrightarrow{Z} -4\delta[n] + 4\left(\frac{1}{4}\right)^n u[n] = x[n]$$

but it is also, in a more direct and simplified way:

$$\left. \begin{array}{l} RC \equiv |Z| > \frac{1}{4} \\ X_1(z) = \frac{1}{1 - \frac{1}{4}Z^{-1}} \\ X(z) = Z^{-1} X_1(z) \end{array} \right\} \xleftrightarrow{Z} \left\{ \begin{array}{l} \left(\frac{1}{4}\right)^n u[n] = x_1[n] \\ x[n] = x_1[n-1] = \left(\frac{1}{4}\right)^{n-1} u[n-1] = -4\delta[n] + 4\left(\frac{1}{4}\right)^n u[n] \end{array} \right.$$

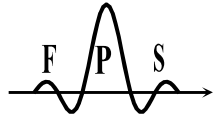

Properties of the Z-Transform

- Multiplication by a complex exponential

$$\boxed{Z_0^n x[n]} \xleftrightarrow{Z} \boxed{X\left(\frac{Z}{Z_0}\right), \quad RC = |Z_0|R_X \equiv |Z_0|r_E < |Z| < |Z_0|r_D}$$

the implication of this operation is to scale all poles and zeroes of $X(z)$ by $|Z_0|$ in the radial direction in case Z_0 is a positive real number, or to rotate all poles and zeroes of $X(z)$ by ω_0 radians, relatively to the origin, in case $Z_0 = e^{j\omega_0}$. This last case corresponds to the modulation property in the Fourier domain (in case the Fourier transform exists):

$$\boxed{e^{j\omega_0 n} x[n]} \xleftrightarrow{F} \boxed{X[e^{j(\omega-\omega_0)}]}$$

example:

$$\left. \begin{array}{l} \boxed{u[n]} \\ \boxed{x[n] = r^n \cos(\omega_0 n) u[n]} \end{array} \right\} \xleftrightarrow{Z} \left\{ \begin{array}{l} \boxed{\frac{1}{1-Z^{-1}}, \quad RC = |Z| > 1} \\ ? \end{array} \right.$$

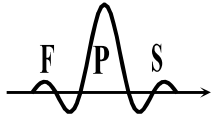

Properties of the Z-Transform

solution:

as
$$x[n] = r^n \cos(\omega_0 n) u[n] = \frac{1}{2} (re^{j\omega_0})^n u[n] + \frac{1}{2} (re^{-j\omega_0})^n u[n]$$

we have:

$$\left. \begin{array}{l} \frac{1}{2} (re^{j\omega_0})^n u[n] \\ \frac{1}{2} (re^{-j\omega_0})^n u[n] \end{array} \right\} \xleftrightarrow{Z} \left\{ \begin{array}{l} \frac{1/2}{1 - re^{j\omega_0} Z^{-1}}, \quad RC = |Z| > r \\ \frac{1/2}{1 - re^{-j\omega_0} Z^{-1}}, \quad RC = |Z| > r \end{array} \right.$$

and hence:

$$X(z) = \frac{1/2}{1 - re^{j\omega_0} Z^{-1}} + \frac{1/2}{1 - re^{-j\omega_0} Z^{-1}} = \frac{1 - r \cos \omega_0 Z^{-1}}{1 - 2r \cos \omega_0 Z^{-1} + r^2 Z^{-2}}, \quad RC = |Z| > r$$

- Differentiation of X(z)

$$nx[n] \xleftrightarrow{Z} -Z \frac{dX(z)}{dZ}, \quad RC = R_X$$

example:

$$X(z) = \log(1 + aZ^{-1}), \quad |Z| > a \xleftrightarrow{Z} ?$$

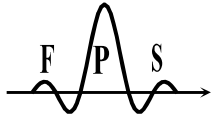

Properties of the Z -Transform

solution:

in this case we have:
$$\frac{dX(z)}{dZ} = -\frac{aZ^{-2}}{1+aZ^{-1}}$$

and thus:
$$nx[n] \xleftrightarrow{Z} -Z \frac{dX(z)}{dZ} = \frac{aZ^{-1}}{1+aZ^{-1}} \xleftrightarrow{Z} a(-a)^{n-1}u[n-1]$$

and finally:
$$x[n] = \frac{a(-a)^{n-1}u[n-1]}{n}$$

- Conjugation

$$x^*[n] \xleftrightarrow{Z} X^*(z^*) \quad , \quad RC = R_X$$

- Inversion in n

$$\left. \begin{array}{l} x[-n] \\ x^*[-n] \end{array} \right\} \xleftrightarrow{Z} \left\{ \begin{array}{l} X(1/z) \quad , \quad RC = 1/R_X \equiv 1/r_D < |Z| < 1/r_E \\ X^*(1/z^*) \quad , \quad RC = 1/R_X \end{array} \right.$$

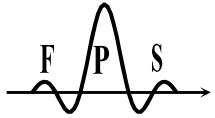

Properties of the Z-Transform

example:

$$\left. \begin{array}{l} a^n u[n] \\ x[n] = a^{-n} u[-n] \end{array} \right\} \xleftrightarrow{Z} \left\{ \begin{array}{l} \frac{1}{1-aZ^{-1}}, \quad |Z| > a \\ X(z) = \frac{1}{1-aZ} = \frac{-a^{-1}Z^{-1}}{1-a^{-1}Z^{-1}}, \quad RC = |Z| < 1/a \end{array} \right.$$

- Convolution

$$x_1[n] * x_2[n] \xleftrightarrow{Z} X_1(z)X_2(z), \quad RC = R_{X1} \cap R_{X2}$$

NOTE: as a result of this operation, *pole-zero cancellation* may occur between the zeroes and poles of the Z function, such that the final RC may be larger than R_{X1} and R_{X2}

- The convolution property is fundamental in the sense that the Z transform of the output of an LTI system is given by the product between the Z transform of the input and the Z transform of the impulse response of the system, commonly known as the transfer function

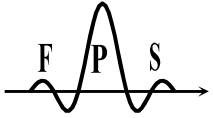

Properties of the Z-Transform

example of the multiplication by a complex exponential property:

let us consider a second-order Z-Transform, $H(z)$, whose zero-pole distribution in the Z-plane is as follows:

```

zero0 = 0.5*exp(1j*3*pi/4);
zero1 = 0.5*exp(1j*5*pi/4);

pole0 = 0.5*exp(1j*pi/4);
pole1 = 0.5*exp(1j*7*pi/4);

b=poly([zero0 zero1]);
a=poly([pole0 pole1]);

zplane(b,a)
  
```

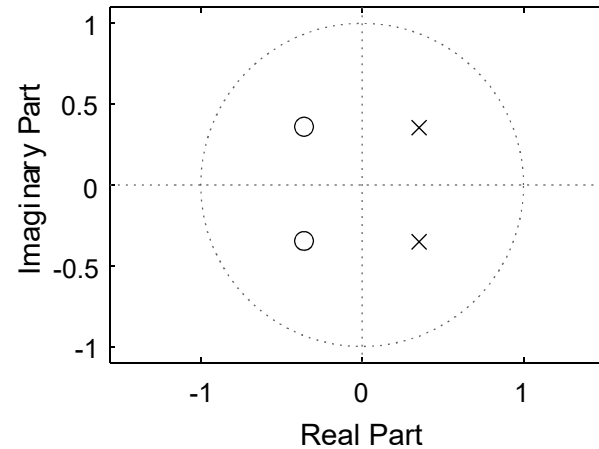

let us now consider the transformations $H\left(\frac{z}{z_0}\right)$, and $H\left(\frac{z}{z_1}\right)$, where $z_0 = 2.56$ and $z_1 = e^{j\pi/4}$

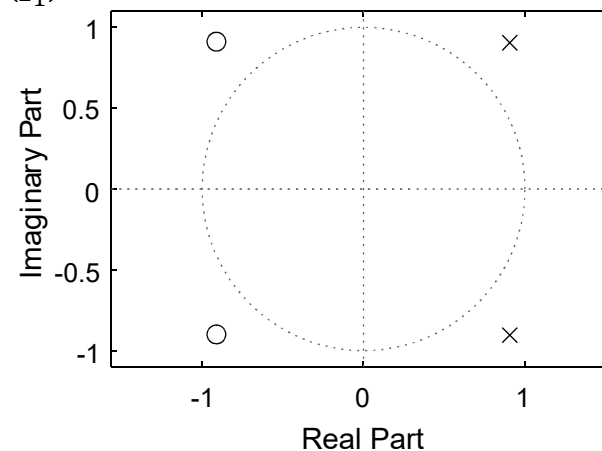
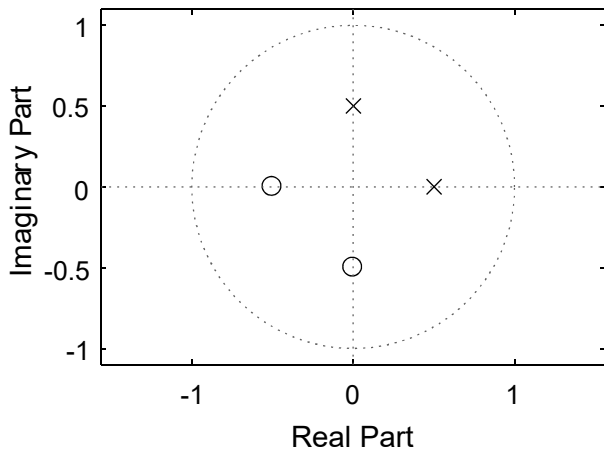

Questions: which plot corresponds to the z_0 transformation ? and to the z_1 transformation ? why ?

Do all the plots correspond to real-valued discrete-time sequences ?

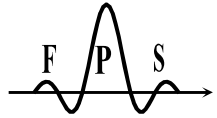

Properties of the Z-Transform

- Multiplication

$$x_1[n] \cdot x_2^*[n] \xleftrightarrow{Z} \frac{1}{2\pi j} \oint_C X_1(v) X_2^*\left(\frac{Z^*}{v^*}\right) v^{-1} dv, \quad RC = R_{X1} \cdot R_{X2}$$

where $R_{X1} \equiv r_{E1} < |Z| < r_{D1}, R_{X2} \equiv r_{E2} < |Z| < r_{D2}, R_{X1} \cdot R_{X1} \equiv r_{E1} \cdot r_{E2} < |Z| < r_{D1} \cdot r_{D2}$

NOTE: C is a closed counter-clockwise contour in the area of intersection between the convergence region of $X_1(v)$ and that of $X_2(Z/v)$. The multiplication property is also known as the modulation theorem or the complex convolution theorem.

- Generalization of the Parseval theorem to the Z domain

As:

$$w[n] = x_1[n] \cdot x_2^*[n] \xleftrightarrow{Z} W(Z) = \sum_{n=-\infty}^{+\infty} x_1[n] \cdot x_2^*[n] Z^{-n}$$

then:

$$\sum_{n=-\infty}^{+\infty} x_1[n] \cdot x_2^*[n] = W(1) = \frac{1}{2\pi j} \oint_C X_1(v) X_2^*\left(\frac{1}{v^*}\right) v^{-1} dv$$

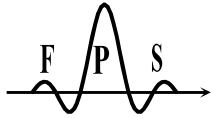

Properties of the Z-Transform

or, changing the variable v into z :
$$\sum_{n=-\infty}^{+\infty} x_1[n] \cdot x_2^*[n] = \frac{1}{2\pi j} \oint_C X_1(Z) X_2^*\left(\frac{1}{Z^*}\right) Z^{-1} dZ$$

If both $X_1(Z)$ and $X_2^*(1/Z^*)$ include the unit circumference in their convergence regions, it is possible to use it as the closed C contour and hence $z=e^{j\omega}$, which leads to:

$$\sum_{n=-\infty}^{+\infty} x_1[n] \cdot x_2^*[n] = \frac{1}{2\pi} \int_{\omega=-\pi}^{\pi} X_1(e^{j\omega}) X_2^*(e^{j\omega}) d\omega$$

As a particular case, the energy of a signal may be evaluated in the Z domain:

$$\sum_{n=-\infty}^{+\infty} |x[n]|^2 = \frac{1}{2\pi} \int_{\omega=-\pi}^{\pi} |X(e^{j\omega})|^2 d\omega = \frac{1}{2\pi j} \oint_C X(Z) X^*\left(\frac{1}{Z^*}\right) Z^{-1} dZ$$

- Initial value theorem

is $x[n]$ is causal (*i.e.*, unilateral Z transform), then:
$$x[0] = \lim_{z \rightarrow \infty} X(z)$$

(gain of the transfer function)

- Final value theorem

if $x[n]$ is causal (*i.e.*, unilateral Z transform), such as that $X(z)$ has all its poles inside the unit circumference, except possibly for a first-order pole at $Z=1$, then:

(gain at low frequencies)

$$\lim_{n \rightarrow \infty} x[n] = \lim_{z \rightarrow 1} (1 - z^{-1}) X(z)$$

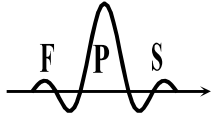

The Z-Transform of the auto/cross-correlation

- the Z-Transform of the auto-correlation
the auto-correlation is defined as (in this discussion, we admit energy signals)

$$r_x[\ell] = x[\ell] * x^*[-\ell] = \sum_{k=-\infty}^{+\infty} x[k]x^*[k - \ell]$$

considering the Z-Transform properties

$$\begin{aligned} x[\ell] &\xleftrightarrow{Z} X(z), & RoC = R_x \equiv r_E < |z| < r_D \\ x^*[\ell] &\xleftrightarrow{Z} X^*(z^*), & RoC = R_x \\ x[-\ell] &\xleftrightarrow{Z} X(z^{-1}), & RoC = 1/R_x \equiv 1/r_D < |z| < 1/r_E \\ x^*[-\ell] &\xleftrightarrow{Z} X^*(1/z^*), & RoC = 1/R_x \end{aligned}$$

Then

$$r_x[\ell] = x[\ell] * x^*[-\ell] \xleftrightarrow{Z} R_x(z) = X(z) \cdot X^*(1/z^*), \quad RoC = R_x \cap 1/R_x$$

where $R_x(z) = X(z) \cdot X^*(1/z^*)$ is called the energy spectrum

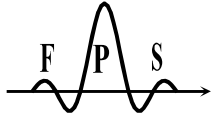

The Z-Transform of the auto/cross-correlation

- the Z-Transform of the auto-correlation (cont.)
 - the Wiener-Khintchine Theorem: the auto-correlation and the energy spectrum form a Z-Transform pair

$$r_x[\ell] \xleftrightarrow{\mathcal{F}} R_x(z) = X(z) \cdot X^*(1/z^*)$$

thus,

$$r_x[\ell] = \frac{1}{2\pi j} \oint_C R_x(z) Z^{\ell-1} dz$$

and, in particular, the energy of the signal can be found using

$$E = r_x[0] = \sum_{k=-\infty}^{+\infty} |x[k]|^2 = \frac{1}{2\pi j} \oint_C X(z) \cdot X^*(1/z^*) Z^{-1} dz$$

which reflects the Parseval Theorem in the Z-domain

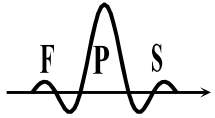

The Z-Transform of the auto/cross-correlation

- the Z-Transform of the cross-correlation
the cross-correlation is defined as (we admit energy signals)

$$r_{xy}[\ell] = x[\ell] * y^*[-\ell] = \sum_{k=-\infty}^{+\infty} x[k] y^*[k - \ell]$$

considering the Z-Transform properties

$$\begin{aligned} x[\ell] &\xleftrightarrow{Z} X(z), & RoC = R_x \\ y[\ell] &\xleftrightarrow{Z} Y(z), & RoC = R_y \\ y^*[\ell] &\xleftrightarrow{Z} Y^*(z^*), & RoC = R_y \\ y[-\ell] &\xleftrightarrow{Z} Y(z^{-1}), & RoC = 1/R_y \\ y^*[-\ell] &\xleftrightarrow{Z} Y^*(1/z^*), & RoC = 1/R_y \end{aligned}$$

then

$$r_{xy}[\ell] = x[\ell] * y^*[-\ell] \xleftrightarrow{\mathcal{F}} R_{xy}(z) = X(z) \cdot Y^*(1/z^*), \quad RoC = R_x \cap 1/R_y$$